

DAMPER / VALVE MOTORS
0-10VDC / 4-20mA

WIRING:

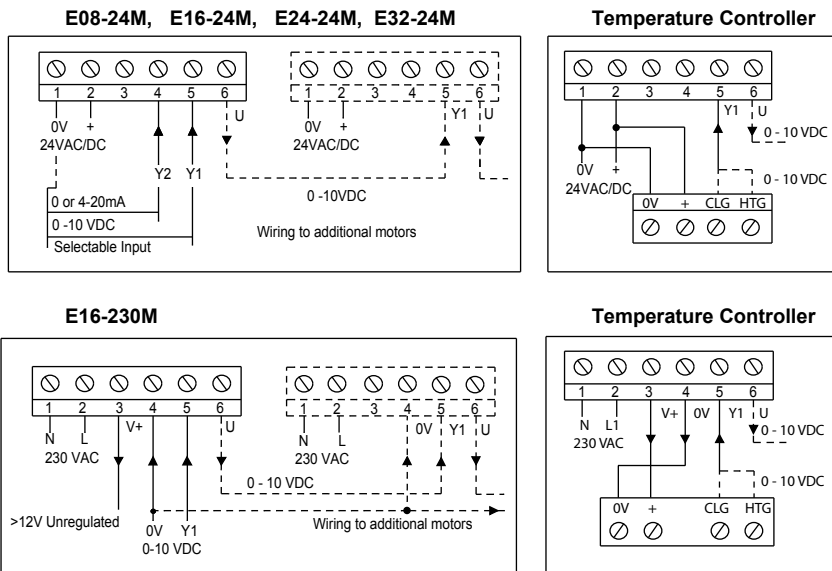

Manual Positioner PAF for E..24M

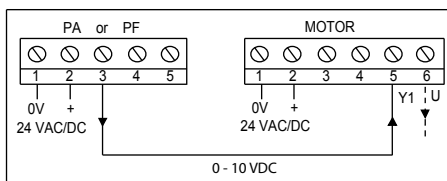

Aux Switches - all ..MS Models

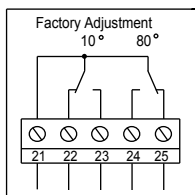

Example
Motor anti-clockwise 21-22 closed at 10° and below
Motor clockwise 21-24 closed at 80° and above

Honeywell 90 E16-20M

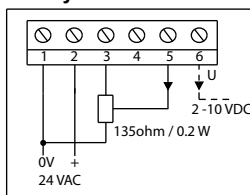

Staefa 0-20v Phase cut E16-20M

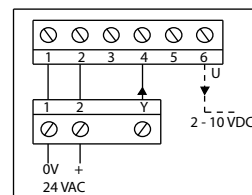

INPUT RESISTANCE Y1 > 100KΩ Y2 500Ω LOAD RESISTANCE U > 50KΩ
ON POWER CUT THE MOTOR STOPS. IF THE INPUT SIGNAL IS CUT, THE MOTOR RETURNS TO 0VDC POSITION.

ADJUSTMENT:

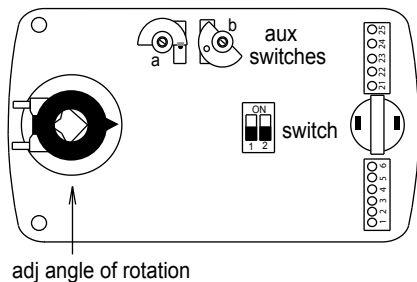

2 x Aux switches Adjustable 0-90°

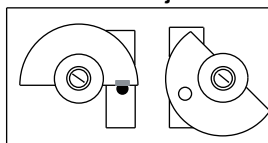

Manually set the motor to the required switching point & rotate the cam wheel to just over the microswitch button. To set the second switching point repeat this using the second cam wheel.

Angle of rotation Adjustable 0-90°

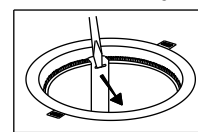

Angle of rotation is adjusted by repositioning the adaptor in 5° steps. The adaptor is released by pressing the locking clip on the underside of the actuator.

Input Signal selection via switch 1

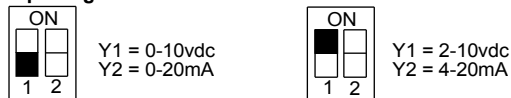

Direction of rotation selection via switch 2

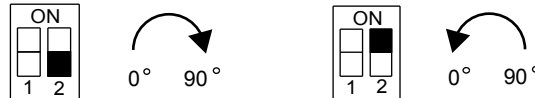

FOR FUNCTIONAL REASONS THE MOTOR PLUG ON MODULATING MOTORS MUST NOT BE REVERSED

INSTALLATION:

Min cable size 7/0.2mm or Screened cable is recommended.

Max length 100m.

The screen should be earthed at controller end only. Keep away from power cables/units which may cause interference.